







28 002 978



- Three settings: COMPACT RAIN, COMPACT SOFT FLOW, COMPACT AQUAPRESSURE FLOW, max. flow rate 6.8 l/min (at 3 bar)
- with anti-scale system
- spray head Ø 95mm
- 1/2" connection
- This product can help a building meet the requirements of Green Building Rating Systems, e.g. LEED®, BREEAM®, DGNB

Intrinsic protection against back flow.

	Chrome	28 002 978-00 0010
	Brushed Platinum	28 002 978-06 0010
	Platinum	28 002 978-08 0010
	Durabrand (23kt Gold)	28 002 978-09 0010
	Brushed Durabrand (23kt Gold)	28 002 978-28 0010
	Brushed Chrome	28 002 978-93 0010
	Brushed Dark Platinum	28 002 978-99 0010

28 002 978

mm [inches]



**Flow rate chart**



**Codes & Standards**

California Energy  
Commission  
(CEC)

Water Sense





## MADISON Hand shower FlowReduce - Chrome

MADISON

28 002 978

### Certificates

LGA\_18610.

IAPMO\_11777.

IAPMO\_4976 (1).

28 002 978

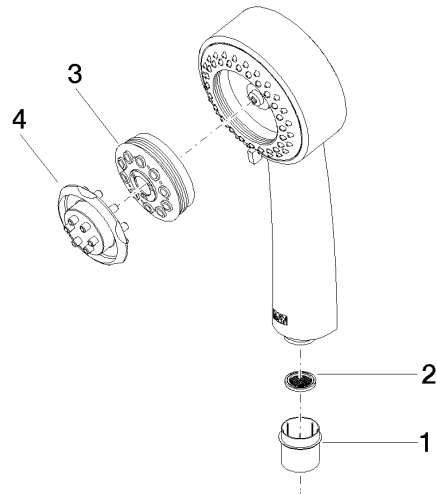

### Spare parts list

No.	Item Number	Name	Quantity used	Delivery time
1	09 21 02 115 90	cap	1	2
2	09 23 01 039 90	sieve	1	2
3	04 12 11 071 00 90	shower	1	2
4	09 30 09 022 90	key	1	2